



Getting to Know Your

SSR



Congratulations on your purchase of a Chevrolet SSR (Super Sport Roadster). Please read this information and your Owner Manual to ensure an outstanding ownership experience. Note that your vehicle may not include all the features described in this booklet. Place this booklet in your Owner Manual portfolio for easy reference.

Table of Contents

Instrument Panel	2	Steering Wheel Audio Controls	9
Instrument Panel Cluster	3	Entertainment Systems	9
Malfunction Indicator Lamp/ Service Engine Soon	4	Driver Information Center	11
Heated Seats	4	Convertible Top	13
Power Seats	4	Cargo Area Cover	13
Memory Driver Seat	6	Cargo Area Accessory Tracks	14
Outside Rearview Mirrors	6	Air Bag Off Switch	14
Interior Lighting	7	Traction Control System	14
Remote Keyless Entry System and Content Theft-Deterrent System	7	Inflator Kit	15
Programmable Automatic Door Locks	8	HomeLink® Transmitter	15
Automatic Headlamp Controls	8	Cupholders and Ashtray	15
		Roadside Assistance Program	16
		My GMLink	16

Instrument Panel

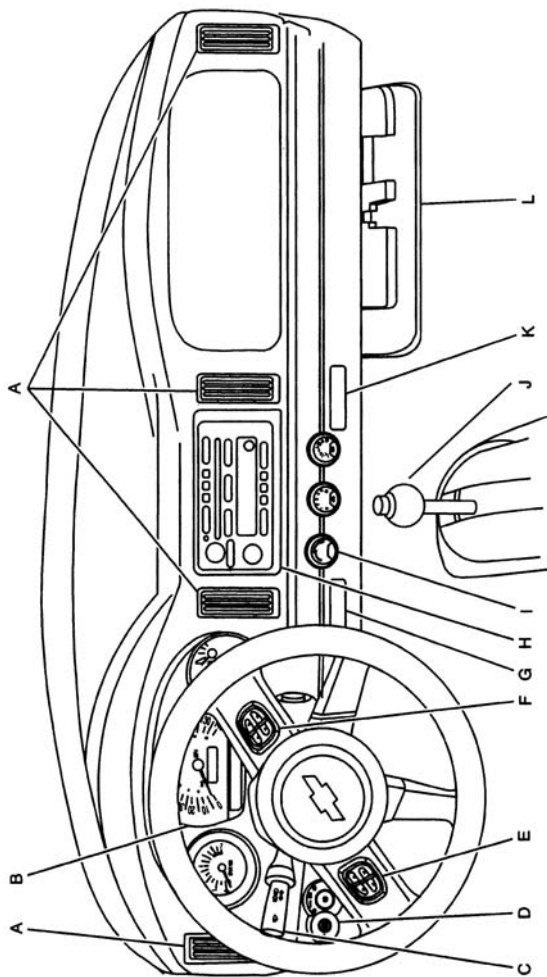

- A. Climate Control Vents
- B. Instrument Panel Cluster
- C. Turn Signal/Multifunction Lever
- D. Exterior and Interior Lamps Control

- E. Driver Information Center (DIC) buttons
- F. Audio Steering Wheel Controls
- G. Storage Tray
- H. Audio System
- I. Climate Control System
- J. Transmission Shift Lever
- K. Cupholder
- L. Glove Box

See Section 3 of your Owner Manual.

Instrument Panel Cluster

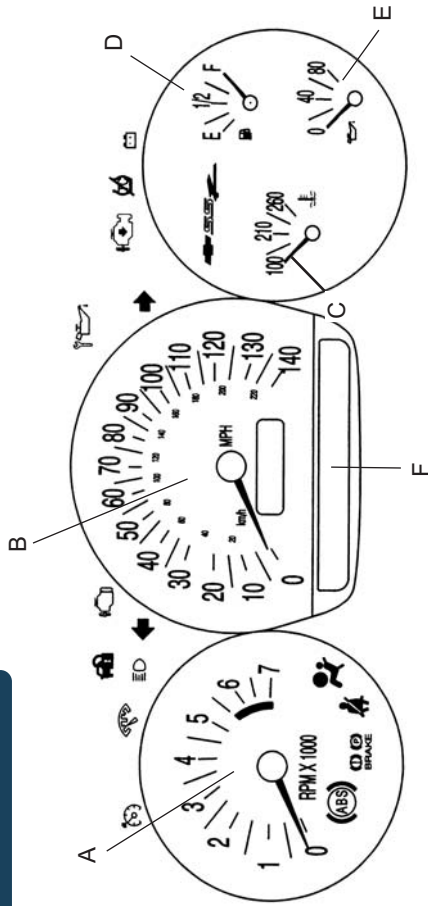

The instrument panel cluster includes these key features:

- A. Tachometer
- B. Speedometer, Odometer, Trip Odometer, Transmission Gear Selector
- C. Coolant Temperature Gauge
- D. Fuel Gauge
- E. Oil Pressure Gauge
- F. Driver Information Center (DIC)

IMPORTANT: The instrument panel cluster is designed to let you know about many important aspects of your vehicle's operation. It is important to read your Owner Manual and become familiar with the information being relayed to you by the lights, gauges and indicators, and what action can be taken to ensure safety and to prevent damage.

See Section 3 of your Owner Manual.

Malfunction Indicator Lamp/ Service Engine Soon



If the Malfunction Indicator Light is Flashing: When it is safe to do so, stop the vehicle and turn the engine off. Wait 10 seconds and restart the engine. If the light stays on steadily, see the steps below. If the light continues to flash, follow the previous steps and see your dealer for service as soon as possible.

If the Malfunction Indicator Light Remains On: If you recently refueled your vehicle, remove and then reinstall the fuel cap, making sure that it is tight (it will make a ratcheting sound). A few driving trips with the cap properly attached should turn the light off.

See Section 3 of your Owner Manual.

Heated Seats (if equipped)



Your vehicle's driver and passenger seats can be heated. The controls are located on the outboard side of the driver and passenger seats. Both the lower cushion and lower seatbacks can be heated. For the low setting, press the lower portion of the switch. For the high setting, press the upper part of the switch. To turn the heat feature off, move the switch to the center position.

Note: To operate this feature, the ignition must be on. When the ignition is turned off, the heater shuts off automatically.

See Section 1 of your Owner Manual.

Power Seats

The power seat controls are located on the outboard sides of the front seats. The driver's seat features six-way power adjustment. The passenger seat has power control for forward and rearward adjustment.



Driver seat controls

Driver's Seat Cushion: Move the front of the seat control (see "A" above) up or down to adjust the front of the driver seat cushion. Move the rear of the seat

control to adjust the rear of the cushion. Move the center of the control to raise or lower the seat. To move the entire seat forward or backward, slide the seat control forward or rearward.

Front Passenger Seat



Passenger seat controls

To move the entire passenger seat forward or backward, slide the seat control forward or rearward and hold until the seat reaches the desired position.

Reclining Seatbacks



To adjust the driver or front passenger seatbacks, lift the lever on the outboard side of the seat cushion. Release the lever to lock the seatback. To position the seatback in a vertical position, lift the lever without pushing on the seatback.

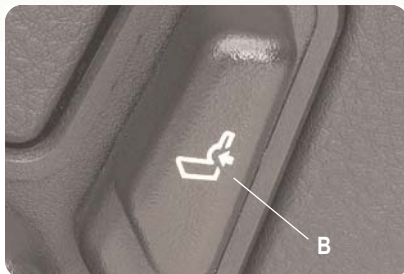

Power Lumbar

For both the driver and passenger seats, the control button (icon) (see "B" above) operates the power lumbar support. Press the button forward for more lumbar support or rearward for less support.

Seatback Latches: Fold the seatbacks forward by pushing the lever on the side of the seatback rearward and moving the seatback forward.

Return the seatback to the upright position by moving it all the way back until the latch catches. (A reclined seatback will return to the reclined position.)

See Section 1 of your Owner Manual.

Memory Driver Seat (if equipped)



Your vehicle may be equipped with a two-driver memory function that is used to recall memory settings for the driver's seating positions for two drivers. The Driver Information Center (DIC) can also be programmed to personalize additional functions. See the DIC section of this guide for more details.

To Program: Adjust the driver's seat to the desired position. Press and hold button "1" on the outboard side of the driver's seat for three seconds, until a chime sounds and the position is stored.

For a second driver, repeat the procedure using button "2."

Recall Seat Position: With the vehicle in PARK (P), press and release button 1 (or 2). A single chime will sound, and the memory position will be recalled. To stop memory feature movement at any time, press one of the power seat controls or memory buttons.

Remote Keyless Entry/Ignition Key

Recall: If programmed to do so through the Driver Information Center (DIC), the ignition key or the unlock button on the remote keyless entry transmitter can be used to recall memory seat and/or DIC personalization settings. The number on

the back of the keyless entry transmitter (1 or 2) corresponds to the number on the seat's memory controls. See the DIC section of this guide for details.

See Sections 2 and 3 of your Owner Manual.

Outside Rearview Mirrors



Power Heated/Automatic Dimming Heated (if equipped): The power mirror control is located on the driver's door. Turn the knob toward the mirror you wish to adjust, move the knob in the direction you want the mirror to go, and return the knob to the center position. Both mirrors are heated when the rear window defogger is activated, to remove mist and fog.

Your vehicle may be equipped with Automatic Dimming Heated Mirrors that adjust for the glare of headlamps behind you. Use the on/off settings on the automatic dimming inside rearview mirror to control them.

See Section 2 of your Owner Manual.

Interior Lighting

Your vehicle is equipped with illuminated entry and exit lighting, interior courtesy lighting and may also be equipped with inside rearview mirror-mounted front map lamps.

Opening a door or pressing the UNLOCK button on your Remote Keyless Entry System transmitter turns on the interior lamps. When exiting, interior lamps turn on when the ignition key is removed.

On equipped vehicles, turn the map lamps on and off by pressing the button near each lamp. To adjust instrument panel brightness, push the interior lamp control button (see "A" below) and release. Turn the control to the desired brightness, then press on it to return it to the stored position.

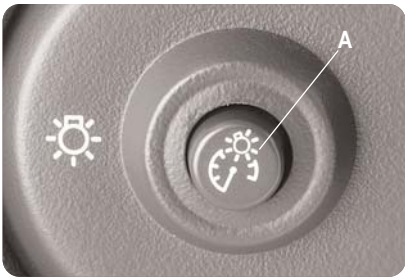

If the interior lamps are left on for more than 10 minutes with the ignition off, the Battery Rundown feature turns them off.

See Section 3 of your Owner Manual.

Remote Keyless Entry and Content Theft-Deterrent System (if equipped)

Use the Remote Keyless Entry System key fob transmitter to:

- **Unlock the vehicle doors.** Press the UNLOCK button (🔓) once to unlock the driver door and twice to unlock both doors; press UNLOCK quickly four times to activate the express-down windows.
- **Lock the doors and arm the Content Theft-Deterrent System.** Press the LOCK button (🔒) once to lock all doors and arm the Content Theft-Deterrent System; press again within three seconds to chirp the horn.
- **Release the cargo area cover.** Press the CARGO AREA COVER RELEASE button (🚪) located in the glove box or press 🚪 on the Remote Keyless Entry.
- **Sound a remote alarm that honks the horn and blinks the headlamps and taillamps for 30 seconds.** Press 📣 to activate and again to deactivate.

The Content Theft-Deterrent System will arm only if you use the key fob or lock the doors with a power lock switch. It will not arm if you lock the door with a key or use the manual door lock. To turn off the alarm, press the UNLOCK button on the key fob or unlock the driver's side door with the key.

The key fob transmitter's range is from 3 to 30 feet. If it doesn't work or range is reduced, check the:

- Distance — you may be too far away
- Location — other vehicles or objects may be blocking the signal
- Battery in the transmitter
- Match of the transmitter to the vehicle (see Owner Manual)

Driver 1 and 2 Memory Settings: The number on the back of the transmitter (1 or 2) corresponds to the memory button numbers on the outboard side of the driver's seat. When the vehicle is unlocked with the transmitter, it recalls the personalized settings for that driver (must be enabled in the Driver Information Center).

See Section 2 of your Owner Manual.

Programmable Automatic Door Locks

The power door locks can be programmed to perform a variety of personalized functions.

Automatic Locking Modes:

- Lock doors when the vehicle is out of the Park (P) position, or
- Lock door when the vehicle speed is over 8 mph (13 km/h) for three seconds.

Automatic Unlocking Modes:

- Unlock both doors in Park (P), or
- Unlock both doors when the ignition key is removed, or
- Unlock driver's door in Park (P), or
- Unlock both doors manually.

To Program:

- Press the Driver Information Center Personalization button (see DIC section of this guide) until AUTOMATIC LOCKING appears on the DIC display.
- Press the SELECT button to select AUTOMATIC LOCKING.
- Press the SELECT button again to scroll through the locking modes.
- When the desired mode is displayed, press the PERSONALIZATION button to set your choice, return to the personalization menu and advance to the next programmable feature.
- Repeat the process to choose one of the automatic unlocking modes.

See Section 2 of your Owner Manual.

Automatic Headlamp Controls

The exterior lamps control is located on the instrument panel, to the left of the steering wheel.

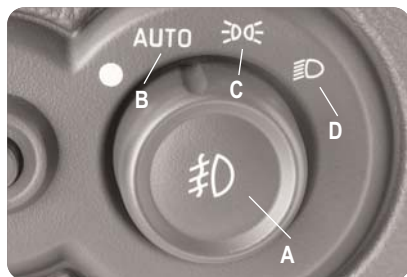

The Fog Lamps button is located in the center of the exterior lamps control ("A" above). Press it to activate or deactivate fog lamps.

The AUTO position (“B” left) activates the automatic headlamp system that illuminates all exterior lamps and the instrument panel/radio lights when they are needed.

The parking lamp position (“C” left) manually illuminates the parking and side-marker lamps, taillamps, instrument panel lights and license plate lamps.

The headlamps-on position (“D” left) manually activates the headlamps, all exterior tail/marker lamps and the instrument panel/radio lights.

See Section 3 of your Owner Manual.

Steering Wheel Audio Controls

You can control certain radio functions using the buttons on your steering wheel.



Press the SEEK button’s up or down arrow (“A” above) to go to the next or previous radio station and stay there.

Press the Volume button’s up or down arrow (“B” above) to increase or decrease audio system volume.

See Section 3 of your Owner Manual.

Entertainment Systems

Setting the clock: With the ignition on or off, press and hold the HR button until the correct hour appears (AM or PM also appears). Adjust minutes by pressing and holding the MN button. To set time to an FM station’s Radio Data System setting, press and hold both HR and MN for two seconds until UPDATED and the clock symbol appears on the display. If the time is not available from the station, NO UPDATE appears in the display.

Radio with CD:



PWR (Power): Press this button to turn the system on or off.

VOL (Volume): Turn this knob to increase or decrease volume.

AUTO VOL (Automatic Volume): Adjusts automatically to compensate for road and wind noise by increasing volume as speed increases. Set the desired volume and push this button to select LOW, MEDIUM or HIGH. AUTO VOL appears on the display. Higher settings provide more compensation as speeds increase. Disable it by pressing AUTO VOL again.

DISP (Display): Press this knob to switch the display between the radio station frequency and the time. For RDS (see RDS), press this knob to select what appears on the display, including station name, RDS station frequency, PTY and the name of the program (if available).

AUDIO: Push and release this knob until BASS or TREB appears on the display; turn to increase or decrease. To set both to the middle position, press and hold the AUDIO knob until it beeps. To adjust all tone and speaker controls to the middle position, push and hold the AUDIO knob when no tone or speaker control is displayed. ALL will appear on the display, and you will hear a beep.

Setting Stations: Six numbered push-buttons let you program up to 18 stations (six each of AM, FM1 and FM2). To program presets:

- Turn the radio on.
- Press BAND to select the band (AM, FM1/FM2).
- Use the seek or tune knob to tune in the desired station.
- Press AUTO EQ to select the equalization that best suits the type of station selected.
- Press and hold one of the six numbered buttons until a beep sounds; release the button.
- Repeat for each numbered preset.

Radio Data System (RDS): Your RDS-equipped radio has the capability to:

- Seek only radio stations with the program types you prefer (such as Jazz, Rock, News, etc.)
- Seek stations with traffic announcements

- Receive announcements concerning local and national emergencies
- Receive and display messages from radio stations

RDS features work only on FM stations that broadcast RDS information and when they broadcast the signal. RDS stations display their station name instead of their frequency. Most RDS stations also provide the time of day and a Program Type (PTY).

ALERT!: Warns of local or national emergencies. You will hear the announcement even if the volume is muted or a CD is playing. It cannot be turned off. This feature is not affected by tests of the Emergency Broadcast System.

TRAF: Press this button to activate the traffic announcement feature. TRAF appears on the display if the tuned station broadcasts traffic announcements. If it doesn't, the radio will seek a station that does. If no station is found, NO TRAF appears on the display. When a traffic announcement comes on the tuned station, you will hear it, even if the volume is muted or a CD is playing.

INFO: If the current station has a message, INFO appears on the audio display. Press this button to see the message. Once the complete message has been displayed, INFO disappears from the display.

P-TYPE LIST: Turn the P-TYPE LIST knob to select the Program Type you want to listen to. Next, press the SEEK TYPE button and the radio will seek the first RDS broadcast of the selected Program Type.

Radio with Six-Disc CD (if equipped):

To load one CD on vehicles equipped with the radio/six-disc CD:

- Turn the ignition on, then press and release the LOAD side of the LOAD CD button.
- Wait for the green indicator light at the right side of the slot to turn green.
- Insert the disc partway into the slot, label side up.

To load multiple CDs:

- Turn the ignition on; then press and hold the LOAD side of the LOAD CD button for two seconds. The unit beeps and the light to the right of the slot begins to flash.
- When the light stops flashing and turns green, insert a disc partway.
- The indicator light begins blinking and turns steadily green. Load another CD.
- When loading more than one but fewer than six CDs, press the LOAD side of the LOAD CD button again to signal that loading is complete.
- When more than one disc is loaded, a number for each disc is displayed.



- To play a specific CD, press the CD AUX button and then the number of the CD you want to hear.

- A small bar appears under the CD number that is playing, and the track number appears.

Bose® System (if equipped): Six-disc Bose® audio systems allow you to choose from four equalization settings:

NORMAL: Provides the best overall sound quality for all seating locations

DRIVER: Gives the driver the best sound quality

SPACIOUS: Makes the listening space seem larger

The radio can save separate AUTO EQ settings for each preset and source. (The AUTO EQ feature automatically adjusts when the retractable hardtop is opened or closed.)

See *Section 3 of your Owner Manual.*

Driver Information Center



The Driver Information Center (DIC) can display trip information, fuel economy information, personalization features, and other messages or warnings. It can be programmed in English, Spanish or French. The DIC display is located on the instrument panel cluster.

The DIC has different modes that can be accessed by pressing the four buttons located on the steering wheel.



Trip Information: Press the Trip Information button (see “A” above) to display the odometer, two trip odometers and the trip timer. To reset the trip odometers or the timer to zero, press and hold the SELECT button (see “D” above) while the desired function is displayed. Use the SELECT button to start and stop the trip timer.

Fuel Information: Press the Fuel Information button (see “B” above) to display current fuel and engine oil information. RANGE estimates the remaining distance you can drive without refueling, based on recent fuel economy and the fuel remaining in the tank.

AVG ECON calculates miles per gallon based on overall driving conditions. Press and hold the SELECT button while AVG ECON is displayed and the DIC will begin calculating the average fuel economy from that point in time.

INST ECON calculates miles per gallon at a particular moment.

ENGINE OIL LIFE estimates the percentage of the engine oil’s remaining useful life. It also alerts you when it is time for an oil change by illuminating the ENGINE OIL LIFE light on the instrument panel. Please remember to always reset the oil life system after an oil change. To reset the Engine Oil Life

monitor, press and hold the SELECT button while ENGINE OIL LIFE is displayed. When successful, the DIC will display ENGINE OIL LIFE: 100%.

Personalization: Press the Personalization button (see “C” above) to access the personalization menu and customize settings for up to two drivers. Press it repeatedly to scroll through the personalization settings, and press the SELECT button when the desired personalization menu item is reached. Identify which driver you are by using your personal key fob transmitter or by pressing the driver number on the memory seat recall button before personalizing.

Select: Press the Select button (see “D” above) to reset certain DIC functions, to acknowledge DIC warning messages and clear them from the DIC, and to set personalization settings. Inside each personalization feature, press the Select button to scroll through menu choices for each feature. Finalize a choice by pressing the PERSONALIZATION button while it is displayed on the DIC and move to the next feature. To reset personalization features to the default mode, hold the TRIP INFORMATION button and the PERSONALIZATION button down for four seconds. If the unit displays a language other than the one you prefer and you are unable to change it, hold these buttons down until the display begins cycling through the three available languages. Release the buttons when you see the preferred language.

Note: This resets the selected driver’s personalization settings to the factory default setting.

Recall driver preferences by pressing any button on the key fob transmitter or by pressing the appropriate memory button 1 or 2 on the driver's seat out-board side.

Saving Preferences: The last value displayed in the DIC for each preference is the saved value, and is saved automatically.

DIC Messages: Many possible messages and warnings can be displayed to alert the driver of open doors, drive system conditions, convertible top and tonneau cover concerns, safety system concerns, and more. See your Owner Manual.

See *Section 3 of your Owner Manual*.

Convertible Top

The Convertible Top will not open or close unless the Cargo Area Cover is completely closed. Attempting to operate the Convertible Top control while the Cargo Area Cover is open or ajar will cause the CARGO COVER AJAR message to appear in the Driver Information Center. If you determine that the Cargo Area Cover is securely closed and the Convertible Top still will not operate, check for a blown fuse (see Owner Manual, Section 5).

Convertible Top Operation: With the key in RUN, place your foot on the brake and press the convertible top switch located on the console switchbank to operate the top.

TOP OPEN: Press and hold  on the switch to open the top. Windows lower automatically when the top begins to lower, and two chimes sound when the top is fully open.

TOP CLOSED: Press and hold  on the switch to close the top. Two chimes sound when the top is fully closed.

In the event of a power loss, where a fuse is not the cause, you may need to raise the roof tonneau and convertible top manually. Two people are required. See your Owner Manual for full details.

See *Section 2 of your Owner Manual*.

Cargo Area Cover

Opening the Cargo Area Cover

- **Caution:** To help avoid damage, the convertible top must be fully open or fully closed when opening the cargo cover.
- Press the button located in the glove box, or use the remote keyless entry transmitter () to release the cargo cover.
- From the rear edge, lift the Cargo Area Cover. The cover will tilt open.
- If you wish, reach inside and release and lower the tailgate using the handle located in the center on the inside of the tailgate.

Closing the Cargo Area Cover

Note that the cargo area is “air tight” which means you must follow these steps to close the Cargo Area Cover:

- Make sure tailgate is partially open
- Close the cargo area cover.
- Close and make sure the tailgate is securely latched.

To open the cover manually, locate the control box under the rear of the vehicle on the driver side, behind the rear tire.



Insert the convertible top release tool (from the glove box) or your ignition key and turn it to activate the emergency release. To remove the cargo cover, see your Owner Manual for full details.

See Section 2 of your Owner Manual.

Cargo Area Accessory Tracks

Four tracks are located in the cargo area: two on the floor and two on the sides that can be used to attach GM accessories. These provide enhanced utilization of your cargo area. (See your dealer for full details.)

See Section 2 of your Owner Manual.

Air Bag Off Switch



A key-activated switch in the glove box turns off the right-front passenger air

bag. Insert your ignition key into the switch and turn it to the "AIR BAG OFF" position. Turn the air bag back on by pushing the key in and turning clockwise to the ON position. An indicator light located above the inside rearview mirror will illuminate when the switch is turned off. (Restrictions apply. See your Owner Manual for full details.)

See Section 1 of your Owner Manual.

Traction Control System

The Traction Control System (TCS) is designed to limit wheelspin when sensing a loss of traction at one or both rear wheels. Engine power is reduced and the transmission may upshift to help limit wheelspin.

The system is activated whenever the engine is started. To turn it off, press the button on the center console switchbank marked "TC."



When off, the Traction Control System's "OFF" telltale light will illuminate and remain on. Turn the system back on at any time by pressing the button again. The system will default to ON when the ignition is cycled.

See Section 4 of your Owner Manual.

Inflator Kit

An inflator kit is located behind the driver seat. To use it, loosen the two nuts holding the cover in place, remove the cover and pull the kit out by its handle.

It contains emergency tire repair components, as well as an air compressor that plugs into the Accessory Power Outlet.

See *Section 5 of your Owner Manual*.

HomeLink® Transmitter (if equipped)

You can program up to three channels to automatically operate items such as garage door openers and electric gates.



To program the HomeLink® transmitter:

1. Press and hold the two outside HomeLink® buttons located on the bottom of the inside rearview mirror. Release them only after about 20 seconds when the light flashes. Do not repeat this step when programming the second and third HomeLink® buttons.
2. Hold your hand-held transmitter about 1 to 3 inches (3 to 8 cm) from HomeLink® and simultaneously press and hold the transmit button on the transmitter and the desired HomeLink® button. Continue to hold both buttons until the indicator light

begins to flash rapidly (up to 90 seconds).

3. Press and hold the newly trained HomeLink® button and observe the indicator light. If the indicator stays on constantly, programming is complete and your device should activate when the HomeLink® button is pressed.

To program “rolling code” devices, see your Owner Manual.

See *Section 2 of your Owner Manual*.

Cupholders and Ashtray

A cupholder is located on the instrument panel and a second removable one snaps to the passenger-side center console. Open the cupholder in the instrument panel by pushing in the center of the cupholder door to release it outward. To close it, push in the center of the cupholder door near the top.

The ashtray is located in the center instrument panel door. Open it by pushing the upper edge of the door until it clicks and then release it to expose the ashtray and cigarette lighter.

See *Sections 2 and 3 of your Owner Manual*.



Roadside Assistance Program

1-800-CHEV-USA (1-800-243-8872)

TTY: 1-888-889-2438

As the owner of a Chevrolet, membership in the Chevrolet Roadside Assistance Program is free.

Roadside Assistance is available 24 hours a day, 365 days a year by calling one of the above numbers. An advisor will provide you with over-the-phone roadside assistance with minor mechanical problems. If the problem can't be resolved over the phone, our advisors have access to a nationwide network of dealer-recommended service providers.

Roadside membership is free; however, some services may incur costs.

Roadside offers two levels of service: Basic Care and Courtesy Care.

Roadside *Basic Care* provides:

- Toll-free number (shown above)
- Free towing for warranty repairs
- Basic over-the-phone technical advice
- Available dealer services at reasonable costs (i.e., wrecker services, locksmith/key service, glass repair)

Roadside *Courtesy Care* provides:

- Roadside Basic Care services (as outlined previously)
Plus:
- FREE Non-Warranty Towing (to the closest dealer from a legal roadway)

- FREE Locksmith/Key Service (when keys are lost on the road or locked inside)
- FREE Flat Tire Service
- FREE Jump Start (at home or on the road)
- FREE Fuel Delivery (\$5 of fuel delivered on the road)

Courtesy Care is available to retail and retail lease customers operating newer Chevrolet vehicles for a period of 3 years/36,000 miles (60,000 km), whichever occurs first.

For prompt and efficient assistance when calling, please provide the following information to the advisor:

- Vehicle Identification Number (VIN)
- Vehicle license plate number
- Vehicle color and mileage
- Location of the vehicle
- Telephone number where you can be reached
- Description of problem

My GMLink

The Chevrolet Owner Center at MyGMLink is a complimentary service for Chevrolet Owners, a one-stop resource to enhance your Chevrolet ownership experience. Exclusive member benefits include online service reminders, vehicle maintenance tips, online owner manual, special privileges and more. Sign up today at www.mygmlink.com

Certain restrictions, precautions and safety procedures apply to your vehicle. Please read your Owner Manual for complete instructions. All information contained herein is based on information available at the time of printing and is subject to change without notice. Copyright 2003 by GM Corp. All rights reserved.



04SSRQRG

CHEVROLET